**FEATURES**

- 80 Amps @ 14VDC Continuous Carry
- PC Terminal or Quick Connect Mounting
- Compatible with Socket SC795
- Suitable for Automotive Accessories
- Contact Material, Coil Power & Contact Gap Optimized
- 2.3W Coil Power

**CONTACT RATINGS**

Contact Form	1C SPDT
Contact Rating	1C NO 80A @ 14VDC, resistive NC 60A @ 14VDC, resistive NO 40A @ 24VDC, resistive NC 30A @ 24VDC, resistive

**CHARACTERISTICS**

Insulation Resistance	100 MΩ min. at 500 VDC
Dielectric Strength	500 Vrms, 50 Hz, between contacts 500 Vrms, 50 Hz, between coil & contacts
Power Consumption	2.3W
Terminal Strength	8N quick connect, 4N PCB pins
Solderability	260°C 5 s ± 0.5 s
Operating Temperature	-40°C to 125°C
Storage Temperature	-40°C to 155°C
Shock Resistance	147 m/s <sup>2</sup> 11 ms
Vibration Resistance	10-40Hz; 1.5mm double amplitude
Weight	47.0g

**CONTACT DATA**

Maximum Switching Power	1,120 W	
Maximum Switching Voltage	75 VDC	
Maximum Continuous Current	80 A	
Material	AgSnO <sub>2</sub>	
Initial Contact Resistance	30 mΩ max.	
Service Life	Mechanical	1 x 10 <sup>7</sup> operations
	Electrical	1 x 10 <sup>5</sup> operations

Values can change due to the switching frequency, desired reliability levels, environmental conditions, and in-rush current levels. It is recommended to test to actual load conditions for the application. It is the users responsibility to determine the performance suitability for their specific application. The use of any coil voltage less than the rated coil voltage may compromise the operation of the relay.

**ORDERING INFORMATION**

Example	PC796	-1C	-C	-12	-S	-R	-N	-X
Model:	PC796							
Contact Form:	1C							
Mounting Version:	C = Plug-In C1 = Plug-In with Plastic Bracket C2 = Plug-In with Metal Bracket P = PC Pins P1 = PC Pins with Plastic Bracket P2 = PC Pins with Metal Bracket							
Coil Voltage:	6 = 6VDC 12 = 12VDC 24 = 24VDC							
Contact Material:	Nil = AgSnO <sub>2</sub> H = AgSnO <sub>2</sub> (HV=125)							
Enclosure:	C = Dust Cover S = Sealed S1 = Flux Tight <sup>(1)</sup>							
Parallel Component:	Nil = None D = Diode D1 = Reverse Diode R = Resistor							
Terminal Plating:	Nil = PC Pin N = Tin Plated Terminals, standard on all Plug-In models							
RoHS Compliant:	-X							

(1) Flux Tight relays are constructed such that Flux will not enter the relay in an automated soldering process, they are NOT suitable for water wash cleaning.

**COIL DATA**

Coil Voltage		Resistance (Ohms ± 10%)	Pick Up Voltage Max. VDC	Release Voltage Min. VDC	Coil Power W	Operate Time ms	Release Time ms
Rated	Maximum						
6	7.8	15.6	3.90	0.60	2.3	≤7	≤2
12	15.6	62.6	7.80	1.20			
24	31.2	250.4	15.60	2.40			

DIMENSIONS mm (inches)

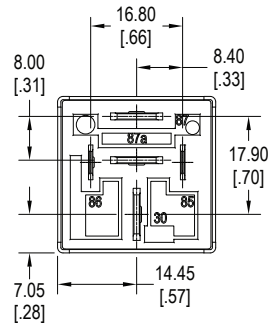
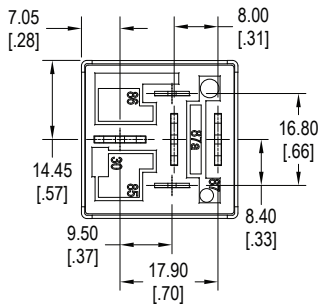
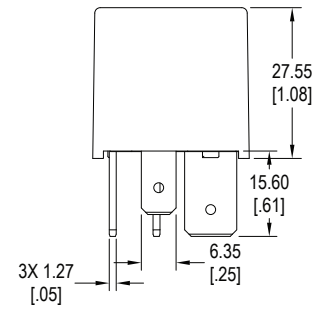
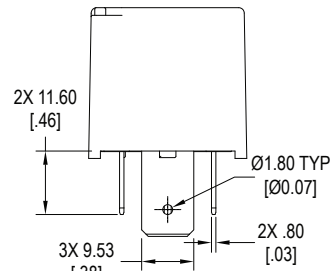
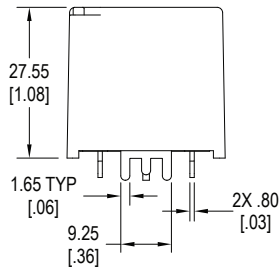
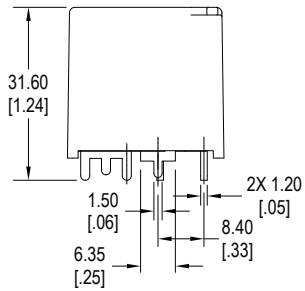
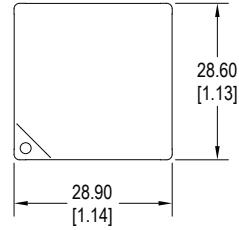
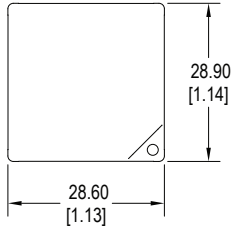

Standard with PC Pins (P)

Standard with Quick Connect (C)

DIMENSIONS mm (inches)

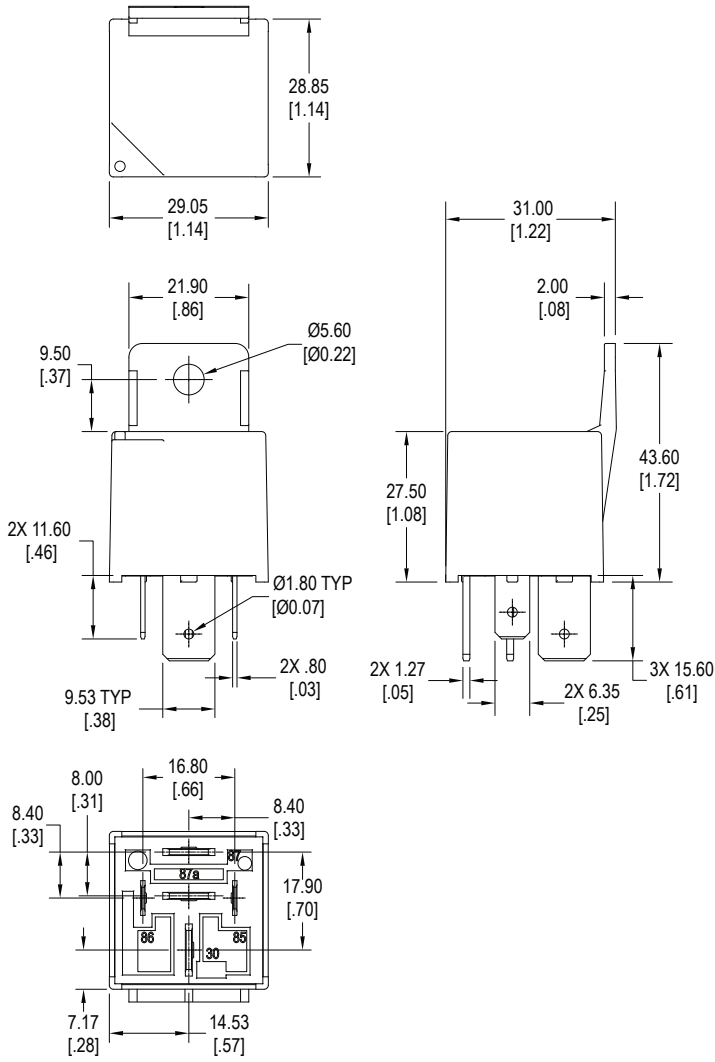

Quick Connect with Plastic Bracket (C1)

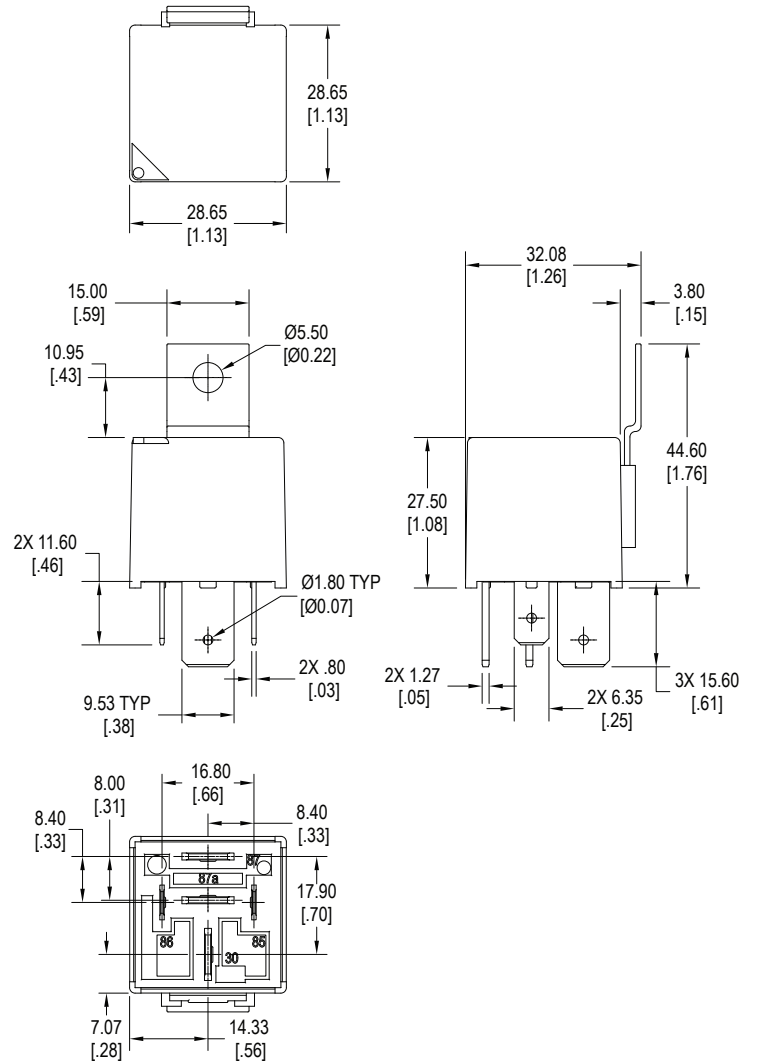

Quick Connect with Metal Bracket (C2)

**SCHEMATICS** *Bottom Views*

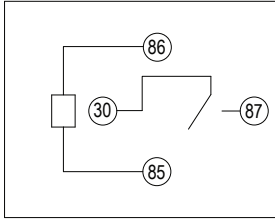

1A

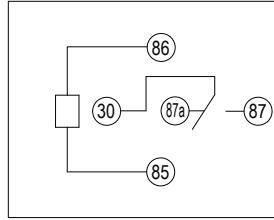

1C

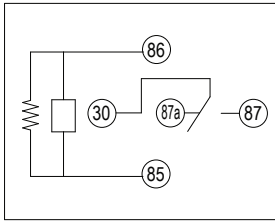

1C with Resistor

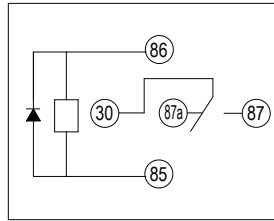

1C with Diode

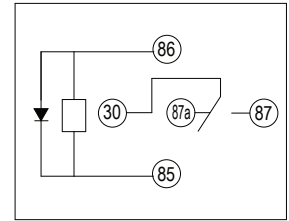

1C with Reverse Diode

**PC LAYOUT**

