

RoHS Compliant

Specifications

Electrical Ratings	50mA @ 48VDC
Electrical Life	100,000 cycles typical
Contact Resistance	<50mΩ initial
Actuation Force	160 ± 50gF
Actuation Travel	.25 ± .1mm

Dielectric Strength	500Vrms min
Insulation Resistance	>100MΩ min
Operating Temperature	-40°C to 85°C
Storage Temperature	-40°C to 85°C

Materials

Actuator	6/6 Nylon (Thru-Hole); 9T Nylon (SMD)
Housing	6/6 Nylon (Thru-Hole); 6T Nylon (SMD)
Cap	6/6 Nylon (Thru-Hole); 6/6 Nylon 33% GF (SMD)
Frame	6/6 Nylon (Thru-Hole); 6/6 Nylon 33% GF (SMD)
Contacts	Stainless Steel, Silver Plated
Terminals	Brass, Silver Plated

Ordering Information

1. Series	CL1200	A	2	2	R	G
CL1200 CL1200V Right Angle CL1200S SMD						
2. Cap Style Blank = No Cap A = Square Cap A1 = Square Cap without LED hole B = Round Cap B1 = Round Cap without LED hole C = Round Cap D = Round Cap E = Round Cap F = Round Cap						
3. Frame Color **Frame not available with CL1200V or RGB LED C = No Frame 2 = Black 9 = Gray						
4. Cap Color A, A1, B & B1 Blank = No Cap 2 = Black 3 = Red 4 = Yellow 5 = Green 9 = Gray	Cap Color C,D, E & F 0 = Clear Semi-Transparent					
5. First LED Color N = No LED R = Red G = Green Y = Yellow B = Blue W = White O = Orange RGB - RBG LED - Not available with A, B or B1 caps; Not available with CL1200V						
6. Second LED Color **For bi-color LED option; white, orange and RGB not available in bi-color Blank = No second LED R = Red G = Green Y = Yellow B = Blue						

CL1200

Illuminated Tactile

Dimensions

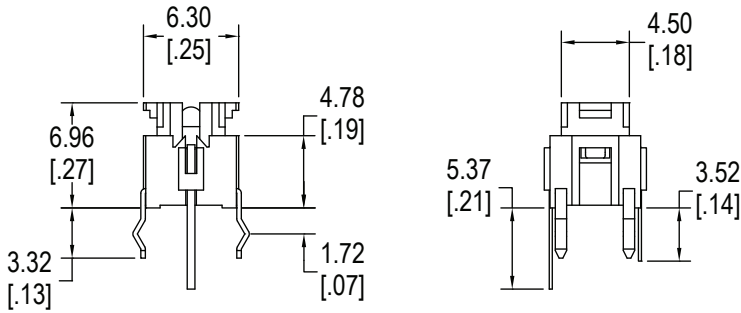
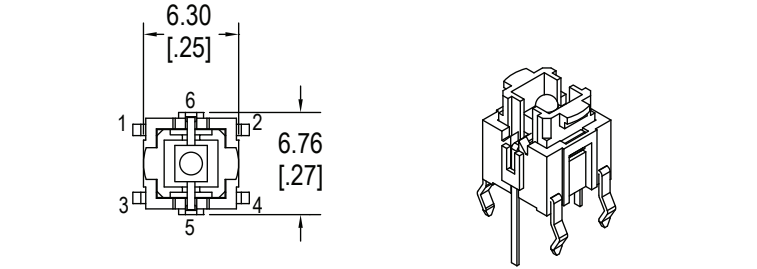

CL1200 for Cap A, A1, B & B1

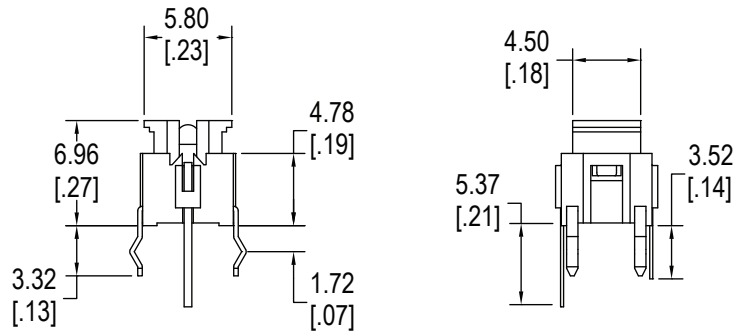
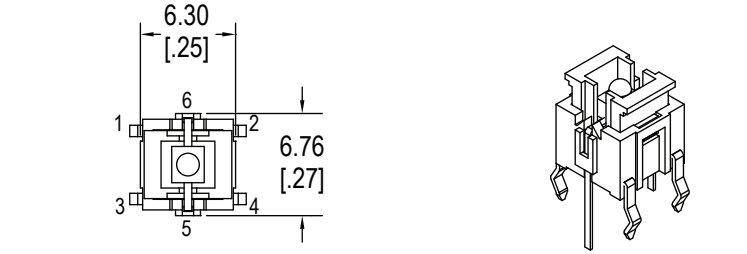

CL1200 for Cap C, D, E & F

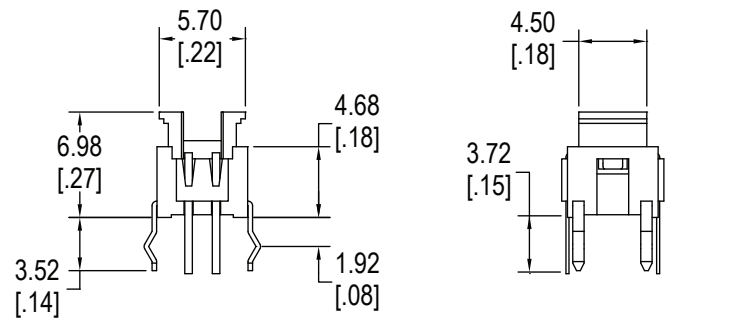
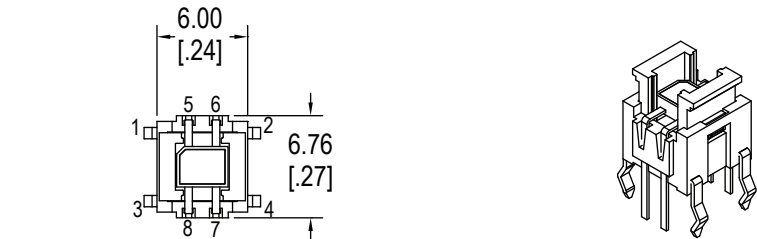

CL1200 for Cap A1, C, D, E & F with RGB LED

Dimensions

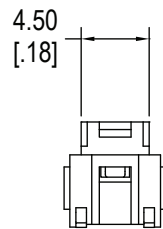
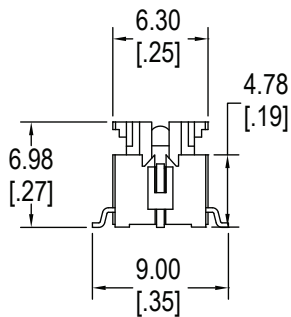
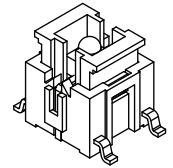
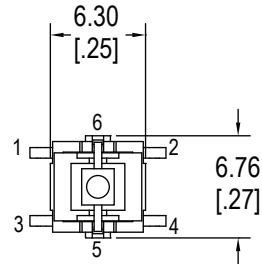
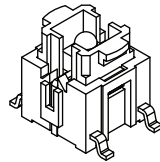
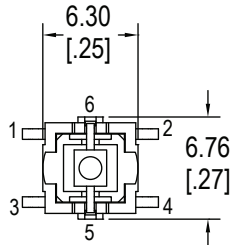

CL1200S for Cap A, A1, B & B1

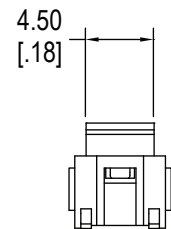
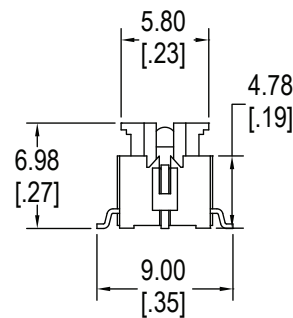

CL1200S for Cap C, D, E & F

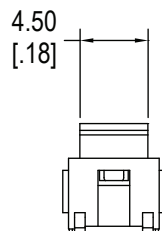
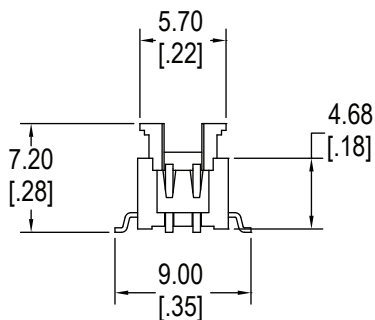
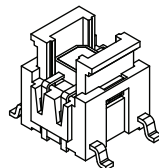
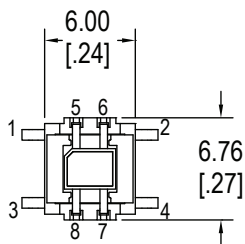

CL1200S for Cap A1, C, D, E & F with RGB LED

CL1200

Illuminated Tactile

Dimensions

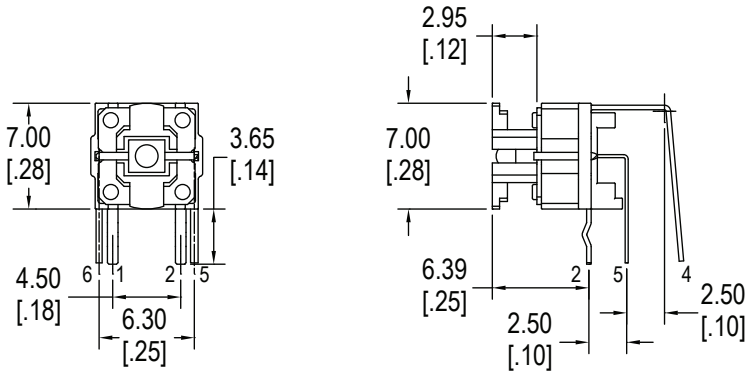
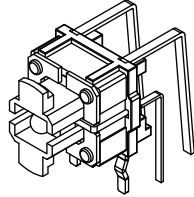
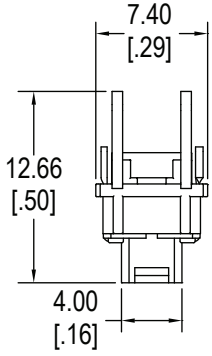

CL1200V

Dimensions - Frames

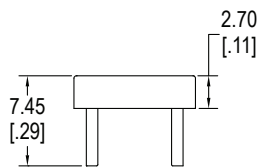
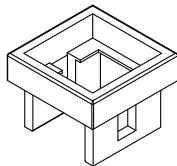
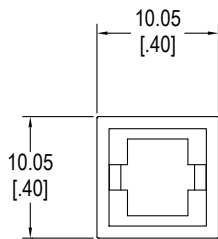

A

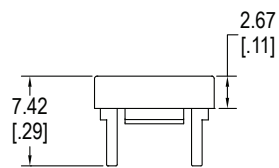
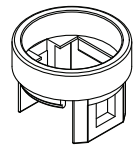
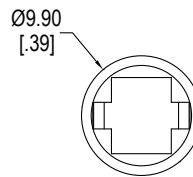

B

Dimensions - Caps

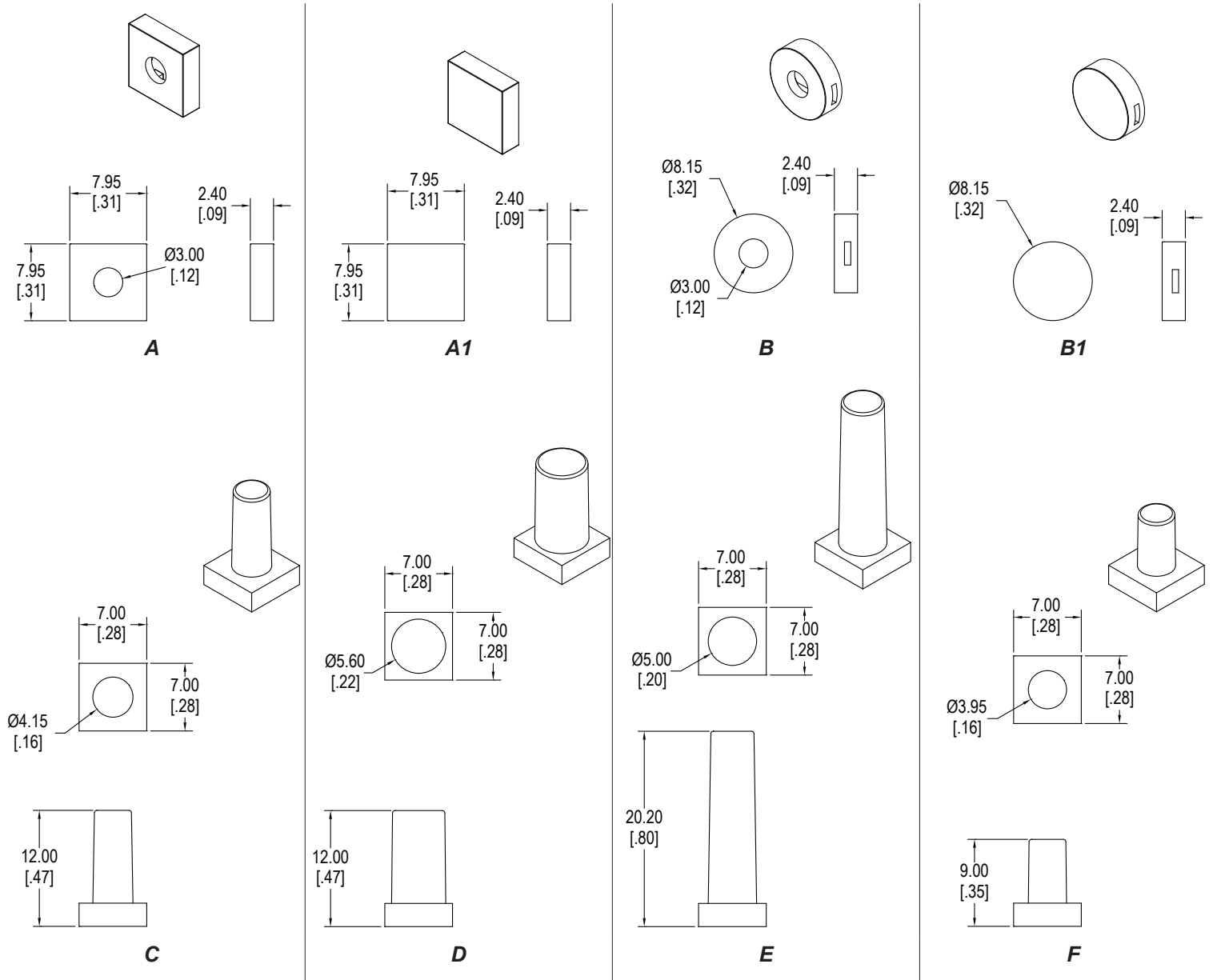

Schematics

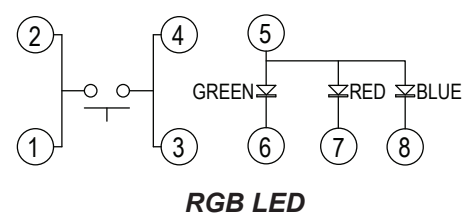
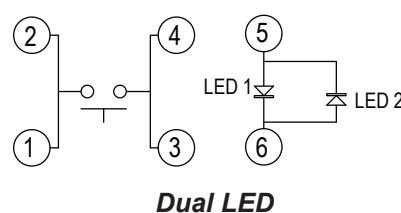
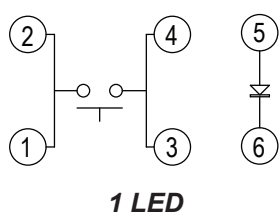

CL1200

Illuminated Tactile

PC Layout

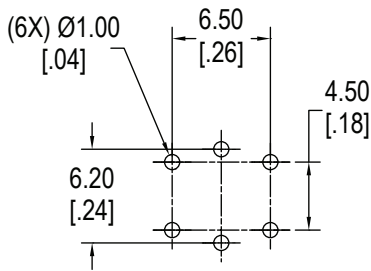

Thru Hole

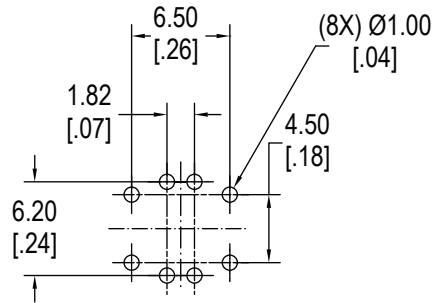

Thru Hole RGB

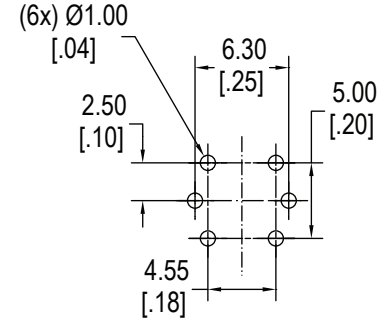

Right Angle

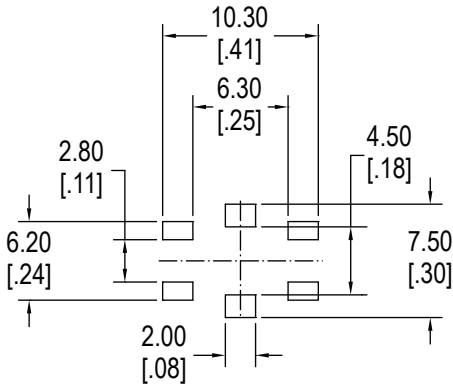

Surface Mount

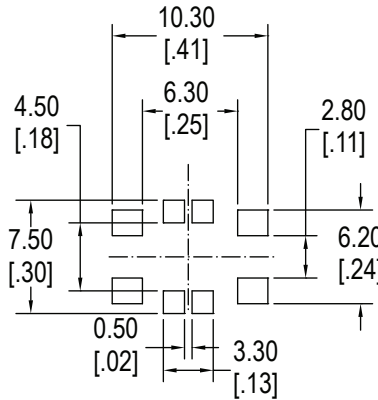

Surface Mount RGB

LED Characteristics

LED Ratings		B	W	O	R	G	Y	Units
		Reverse Voltage	V_R	5	5	5	5	5
Forward Current (avg)	I_F	30	30	30	30	30	30	mA
Forward Current (peak)	I_{FS}	125	125	125	185	150	125	mA
Reverse Current $V_R = 5V$	I_R	10	10	10	10	10	10	μA
Power Dissipation	P_T	120	120	75	75	75	75	mW
Operating & Storage Temperature	T_A	-40 ~ +85						$^{\circ}C$
Forward Voltage (typ) $I_F = 20mA$	V_F	3.5	3.5	2.0	2.0	2.1	2.0	V
Forward Voltage (max) $I_F = 20mA$	V_F	4.0	4.0	2.5	2.5	2.5	2.5	V
Wavelength at Peak Emmission, $I_F = 20mA$	λ_P	460	n/a	610	650	574	590	nm
Spectral Line Half-Width, $I_F = 20mA$	$\Delta\lambda$	40	n/a	610	28	20	590	nm
Luminous Intensity, $I_F = 20mA$	LI	200	60	50	1800	800	1550	mcd
Viewing Angle	Θ	20	165	20	20	20	20	deg