

## Specifications

Electrical Ratings	100mA @ 30VDC
Electrical Life	100,000 cycles typical
Contact Resistance	<50mΩ initial
Actuation Force	180 ± 50gF
Actuator Travel	1.5mm to lock 2.5mm to full travel

Dielectric Strength	1000Vrms min
Insulation Resistance	>100MΩ min
Operating Temperature	-40°C to 85°C
Storage Temperature	-40°C to 85°C

## Materials

Actuator	Acetal
Housing	6/6 Nylon
Cover	Acetal
Latching Pin	Stainless Steel
Spring	Stainless Steel
Contacts	Phosphor Bronze, Silver Plated
Terminals	Brass, Silver Plated

## Ordering Information

1. Series	LP2202	F180	N	C022
LP2202				
2. Actuation Force	F180 = F180gF			
3. Latching	N = Non-Latching * Contact Factory of Latching Option			
4. Cap Options	Cap Colors			
Blank = No Cap	**See Cap Options for color availability			
C01				
C02				
C03				
C04				

# LP2202

## Miniature Pushbutton

### Dimensions

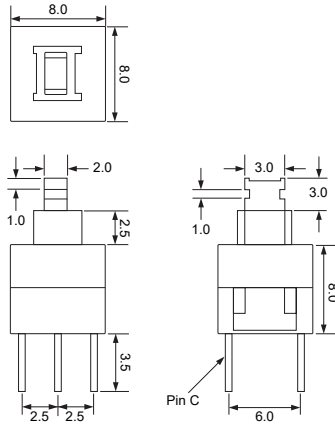

### Schematic & PC Layout

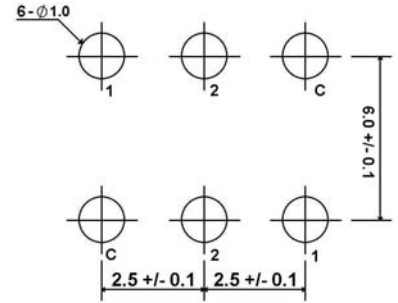
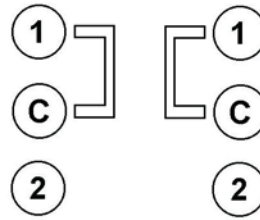

### Cap Options

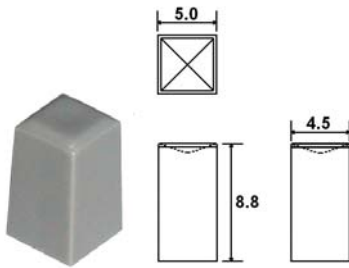

**C01\_**

1 = White, 2 = Black, 3 = Red, 9 = Light Gray  
Contact Factory for other available colors

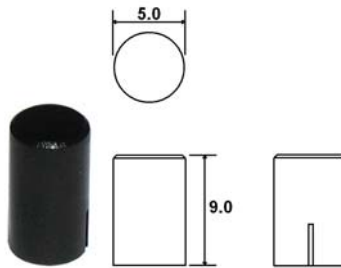

**C02\_**

1 = White, 2 = Black, 3 = Red, 9 = Light Gray  
Contact Factory for other available colors

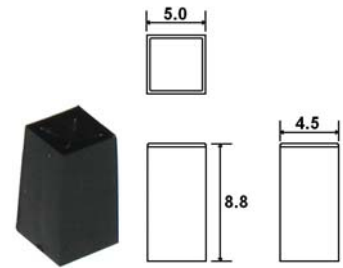

**C03\_**

1 = White, 2 = Black, 3 = Red, 9 = Light Gray  
Contact Factory for other available colors

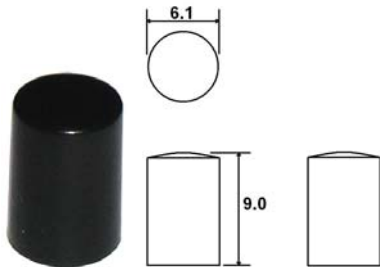

**C04\_**

1 = White, 2 = Black, 3 = Red, 9 = Light Gray  
Contact Factory for other available colors