



Specifications

Electrical Ratings	200mA @ 30VDC
Electrical Life	10,000 cycles typical
Contact Resistance	<50mΩ initial
Actuation Force	250 ± 100gF
Actuation Travel	2.0mm total

Dielectric Strength	1000Vrms min
Insulation Resistance	>100MΩ min
Operating Temperature	-40°C to 85°C
Storage Temperature	-40°C to 85°C

Materials

Actuator	6/6 Nylon
Housing	Steel
Base	Phenolic
Contacts	Phosphor Bronze, Silver Plated
Terminals	Brass, Silver Plated

Dimensions

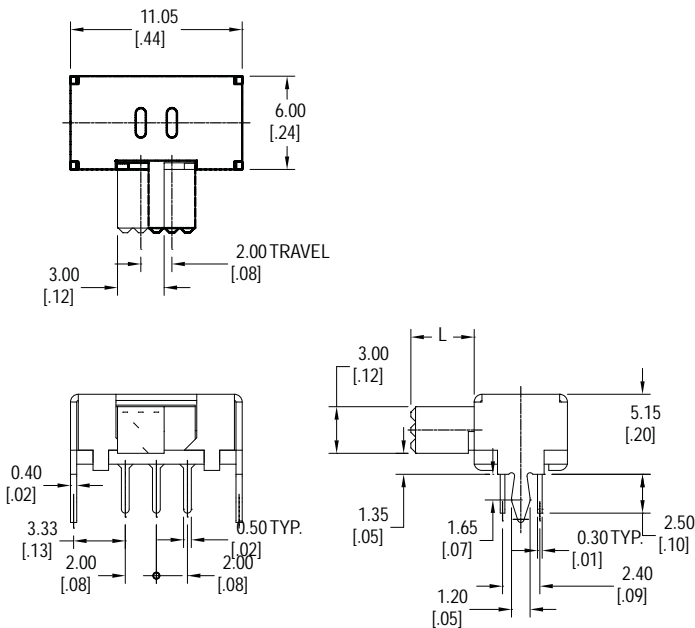

1. Series	MS2211	L4
MS2211		
2. Actuator Length		
L2 = 2mm		
L4 = 4mm		

Schematic & PC Layout

