

UL Approved Illuminated Rocker

Specifications

Electrical Ratings	UL61058-1 20A @ 120VAC 16A @ 250VAC General Purpose 1hp @ 250VAC; 3/4 hp @ 125VAC	Contact Resistance	≤ 50mΩ initial
Switch Function	SPST Illuminated, DPST, DPDT	Dielectric Strength	1500Vrms min
Electrical Life	10,000 cycles typical	Insulation Resistance	≥ 100MΩ min
		Operating Temperature	-30°C to +80°C
		Storage Temperature	-30°C to +80°C
		Sealing Degree	IP40 IP65 with Sealing Boot

Materials

Housing	6/6 Nylon
Actuator	6/6 Nylon, PC Illuminated
Contacts	Silver Alloy
Terminals	Brass, Silver Plated
Lamp	Neon or LED

Ordering Information

1. Series	RW	2	1	2	5T	D	W	C	T12
RW									
2. Number of Poles	2 = Double Pole								
3. Switch Function () = momentary	1 = OFF - NONE - ON **Illumination only available with this function 2 = OFF - NONE - (ON) 3 = (OFF) - NONE - ON 6 = ON - OFF - ON 4 = ON - NONE - ON 7 = (ON) - OFF - (ON) 5 = ON - NONE - (ON) 8 = ON - OFF - (ON)								
4. Housing Color	1 = White 2 = Black 9 = Gray								
5. Actuator Colors	1 = White 4 = Yellow 7 = Blue 1T = White Transparent 5T = Green Transparent 2 = Black 5 = Green 8 = Purple 3T = Red Transparent 7T = Blue Transparent 3 = Red 6 = Orange 9 = Gray 4T = Yellow Transparent								
6. Actuator Marking	A D G J B E H K C F I								
7. Actuator Marking Color	A = No Marking W = White B = Black R = Red								
8. Terminal Options	C = .250" Quick Connects / Solder Lug								
9. Lamp Options	Blank = Non-Illuminated N1 = 125VAC Neon Lamp Y12 = Yellow LED 12V B12 = Blue LED 12V N2 = 250VAC Neon Lamp Y24 = Yellow LED 24V B24 = Blue LED 24V R12 = Red LED 12V G12 = Green LED 12V W12 = White LED 12V R24 = Red LED 24V G24 = Green LED 24V W24 = White LED 24V								

Dimensions

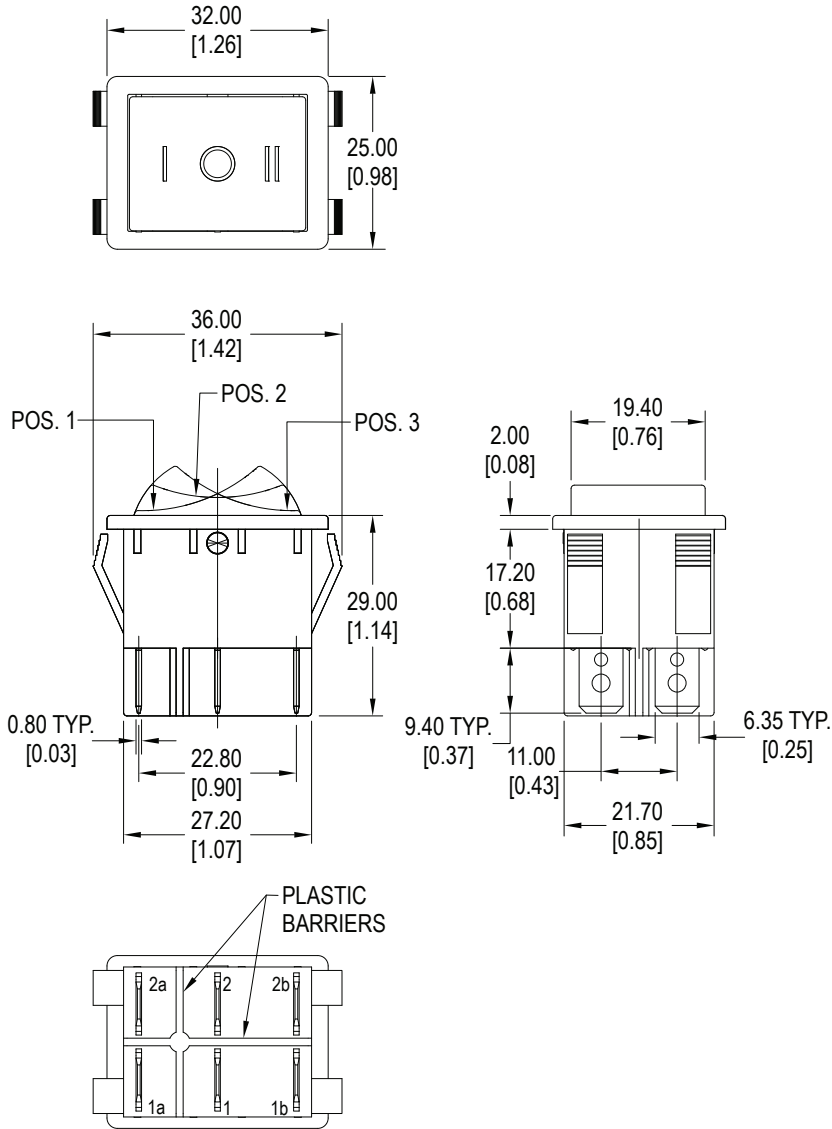

Function	Switch Function		
	Position 1	Position 2	Position 3
1*	OFF	NONE	ON
2	OFF	NONE	(ON)
3	(OFF)	NONE	ON
Terminals	--	--	1 ~ 1a 2 ~ 2a
4	ON	NONE	ON
5	ON	NONE	(ON)
6	ON	OFF	ON
7	(ON)	OFF	(ON)
8	ON	OFF	(ON)
Terminals	1 ~ 1b 2 ~ 2b	--	1 ~ 1a 2 ~ 2a

* Illuminated function only
() = Momentary function

Schematics

DPST

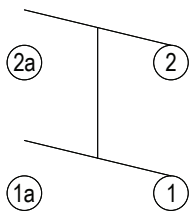

DPDT

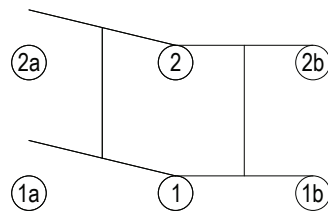

DPDT, Neon Lamp

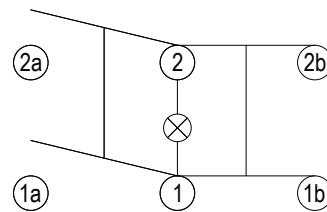

DPDT, LED & Resistor

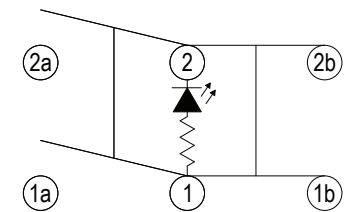

Actuator Marking Options

A Marking



B Marking



C Marking

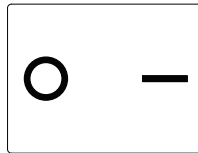

D Marking



E Marking



F Marking



G Marking

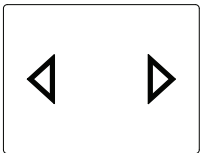

H Marking

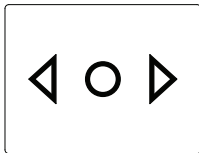

I Marking



J Marking

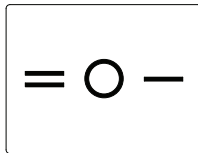

K Marking

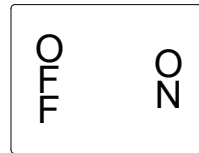

LED Characteristics

LED Ratings		Color					Units
		R	Y	G	B	W	
Reverse Voltage	V_R	5	5	5	5	5	V
Forward Current (avg)	I_F	30	30	30	30	30	mA
Reverse Current $V_R = 5V$	I_R	10	10	10	10	10	μA
Power Dissipation	P_T	56	56	46	72	76	mW
Operating & Storage Temperature	T_A	-40 ~ +85					C°
Forward Voltage (min) $I_F = 20mA$	V_F	1.7	1.7	1.8	2.8	2.8	V
Forward Voltage (max) $I_F = 20mA$	V_F	2.4	2.4	2.4	3.4	3.4	V
Wavelength (min) $I_F = 20mA$	λ_d	620	585	565	460	n/a	nm
Wavelength (max) $I_F = 20mA$	λ_d	630	595	575	470	n/a	nm
Luminous Intensity, $I_F = 20mA$	LI	50	150	30	140	500	mcd
Viewing Angle	Θ	50	50	70	120	70	deg

Panel Cut Out

Panel cut out material thickness : 0.7mm ~ 3.0mm

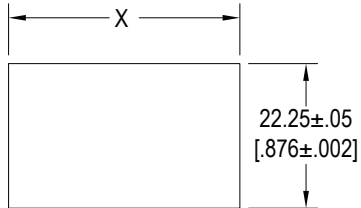

Panel Thickness	X
0.75 ~ 1.25	30.0 ~ 30.2
1.25 ~ 2.00	30.2 ~ 30.4
2.00 ~ 3.00	30.6 ~ 30.8

Terminal Options

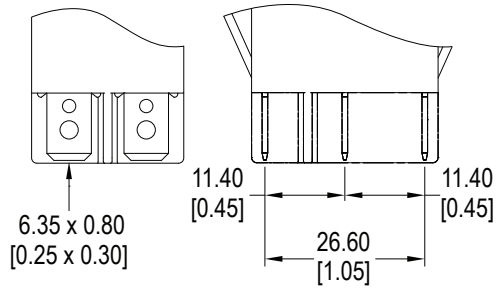

Sealing Boot

